

DESCRIPTION

- ELECTRONIC BALLAST
- ELECTRONIC TRANSFORMER
- SWITCH MODE POWER SUPPLY

FEATURES:

- LOW THERMAL RESISTANCE
- HIGH INPUT RESISTANCE
- FAST SWITCHING
- ROHS COMPLIANT

MAXIMUM RATINGS (T_c=25°C)

PARAMETER	SYMBOL	VALUE	UNIT
Drain-source Voltage	VDS	800	V
gate-source Voltage	VGS	±30	V
Continuous Drain Current (T _C =25°C)	ID	11	A
Drain Current-Pulsed	IDM	30	A
Total Dissipation	PD	85	W
Junction Temperature	T _j	150	°C
Storage Temperature	T _{stg}	-55-150	°C
Single Pulse Avalanche Energy (I _{AS} =11A)	EAS	220	mJ

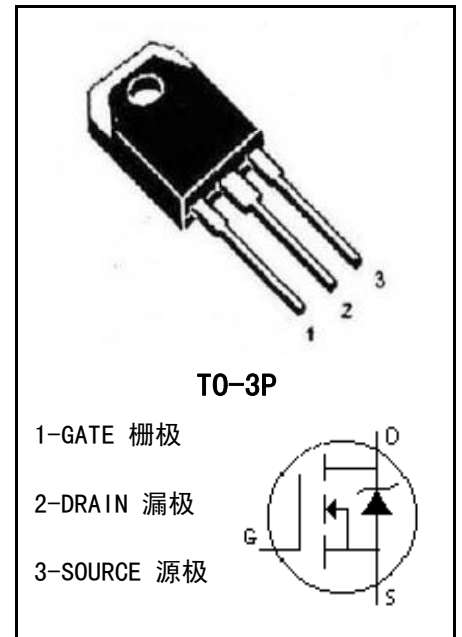
MECHANICAL

ELECTRONIC CHARACTERISTICS (T_c=25°C)

CHARACTERISTICS	SYMBOL	TEST CONDITION	MIN	MAX	UNIT
Drain-source Breakdown Voltage	BVDSS	VGS=0V, ID=250uA	800		V
Gate Threshold Voltage	VGS (TH)	VGS=VDS , ID=250 μ A	2.5	4.5	V
Drain-source Leakage Current	IDSS	VDS=800V, VGS=0V		1	uA
Drain-Source Diode Forward Voltage	VSD	VGS=0V, IS=5.5A		1.5	V
Gate-body Leakage Current (VDS = 0)	IGSS	VGS=±30V		±100	nA
Forward Transconductance	gfs	Vds=10V Id=5.5A	0.5		S
Static Drain-source On Resistance	RDS (ON)	VGS=10V, ID=5.5A		0.5	Ω
Thermal Resistance Junction-case	RthJ-c			1.5	°C/W

■ DYNAMIC CHARACTERISTICS (T_c=25°C)

CHARACTERISTICS	SYMBOL	TEST CONDITION	MIN	TYP	MAX	UNIT
Input Capacitance	C _{iss}	V _{DS} =25V, V _{GS} =0V, f=1.0MHz	-	675	-	pF
output Capacitance	C _{oss}		-	235	-	pF
Reverse Transfer Capacitance	C _{rss}		-	7	-	pF

■ SWITCHING CHARACTERISTICS (T_c=25°C)

CHARACTERISTICS	SYMBOL	TEST CONDITION	MIN	TYP	MAX	UNIT
Turn-On Delay Time	t _{d(on)}	V _{DD} =400V, I _D =5.5A, R _G =20Ω	-	16	-	ns
Turn-On Rise Time	t _r		-	12	-	ns
Turn-Off Delay Time	t _{d(off)}		-	115	-	ns
Turn-Off Rise Time	t _f		-	9	-	ns
Total Gate Charge	Q _g	V _{DS} =480V, I _D =5.5A, V _{GS} =10V	-	38	-	nC
Gate-Source Charge	Q _{gs}		-	4	-	nC
Gate-Drain Charge	Q _{gd}		-	4.2	-	nC

■ DRAIN-SOURCE DIODE MAXIMUM RATINGS AND CHARACTERISTICS (T_c=25°C)

CHARACTERISTICS	SYMBOL	TEST CONDITION	MIN	TYP	MAX	UNIT
Max. Diode Forward Current	I _s		-	-	11	A
Max. Pulsed Forward Current	I _{SM}		-	-	30	A
Diode Forward Voltage	V _{SD}	V _{GS} =0V, I _S =5.5A	-	-	1.5	V
Reverse Recovery Time	t _{rr}	V _{GS} =0V, I _S =5.5A, dI _F /dt=100A/μs, V _{DD} =100V	-	275	-	ns
Reverse Recovery Charge	Q _{rr}		-	3.5	-	μC



CHARACTERISTICS CURVE

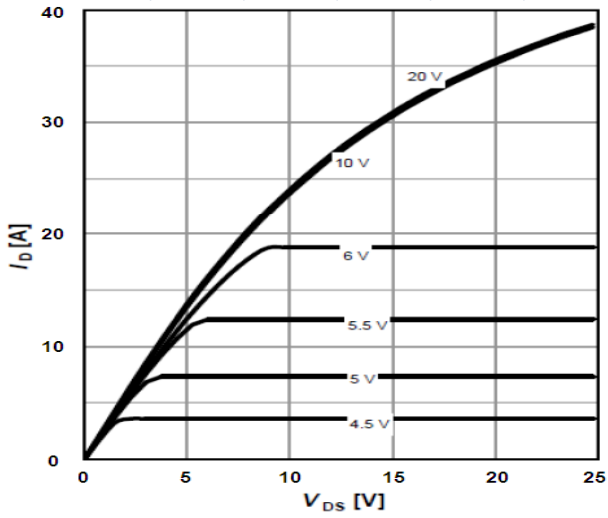

Output Characteristic

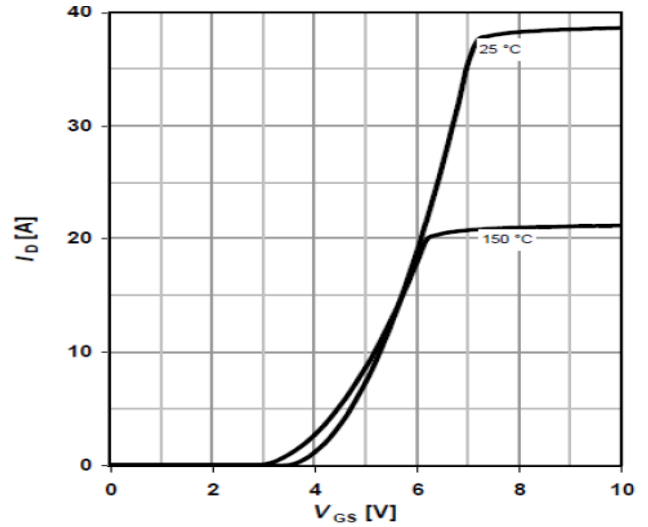

Transfer Characteristic

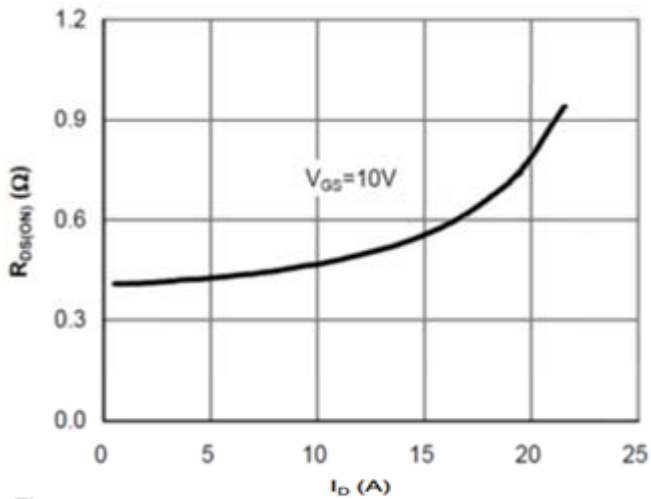

On-Resistance vs. Drain Current and Gate Voltage

On Resistance Vs Drain Current

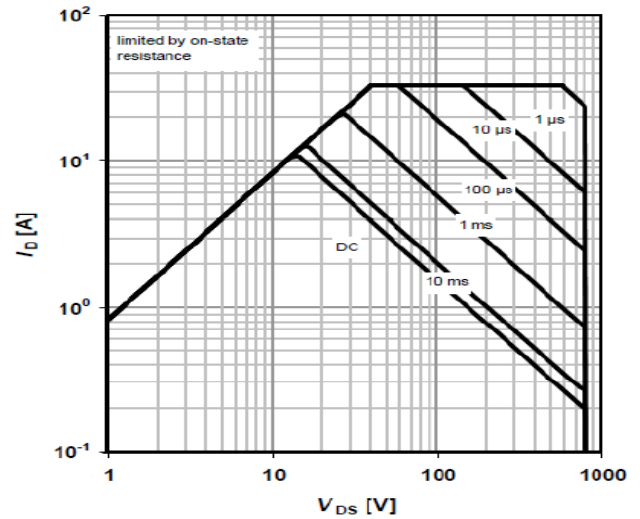

Safe Operating Area

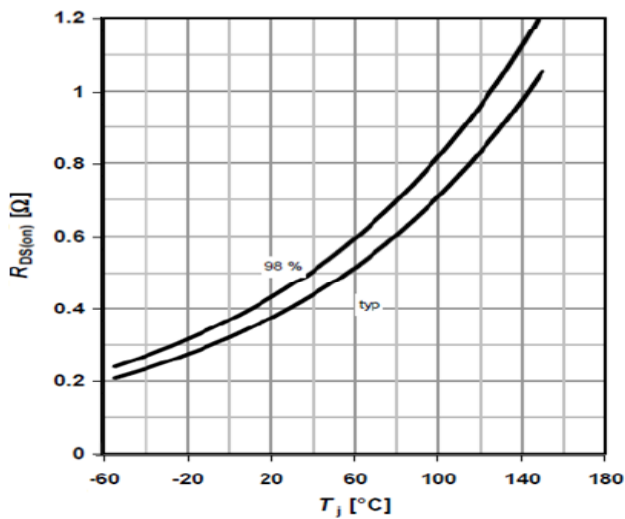

On Resistance Vs Junction Temperature

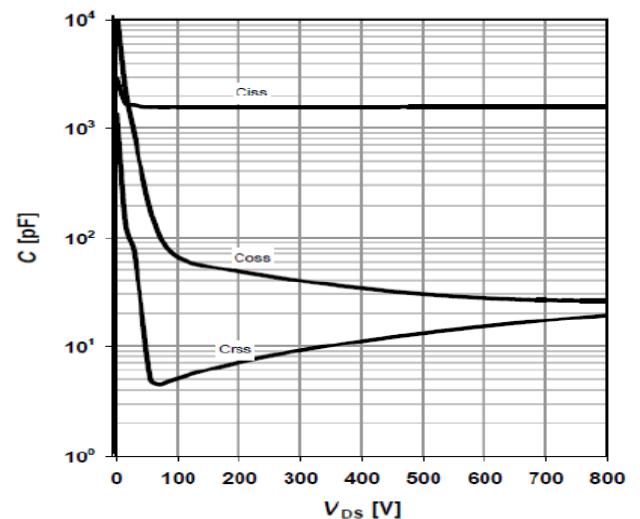

Capacitance



CHARACTERISTICS CURVE

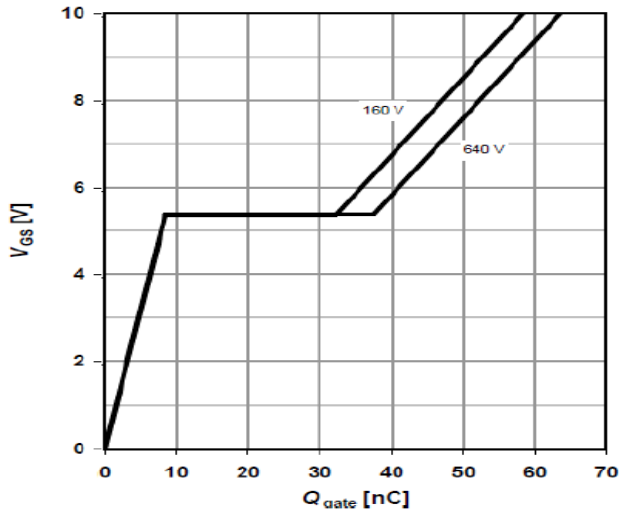

Gate Charge Waveform

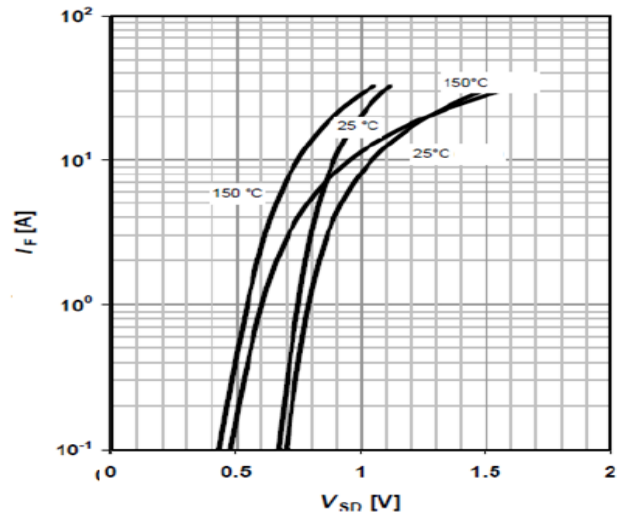

Source-Drain Diode Forward Voltage

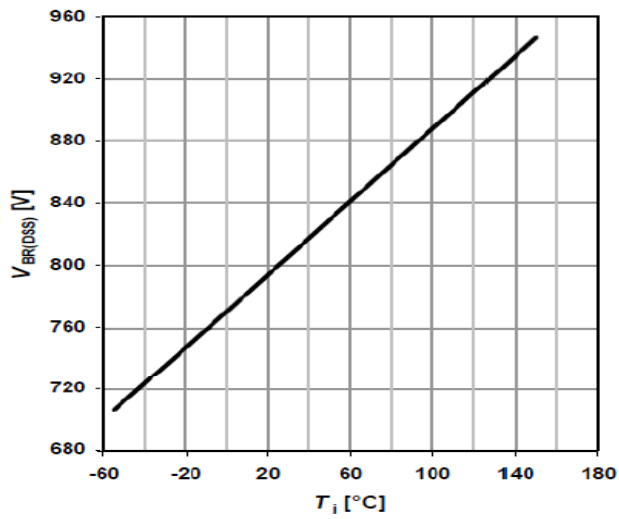

Breakdown Voltage Vs Junction Temperature

TO-3P MECHANICAL DATA

UNIT: mm

SYMBOL	TYPE	SYMBOL	TYPE
A	15.5	J	3.6
B	12.5	K	2.0
C	10.0	L	3.0
D	3.2	M	1.0
E	5.0	N	5.45
F	19.3	O	4.9
G	18.1	P	2.0
H	13.9	Q	2.9
I	20.0	R	0.6

